



M A R I N E

MCD5060

MARINE CD PLAYER / RECEIVER

Installation and Operation Manual

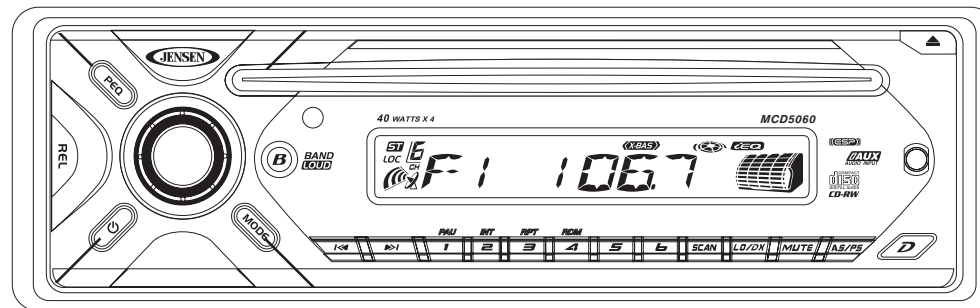

SAFETY INFORMATION

When Driving

Keep the volume level low enough to be aware of the road and traffic conditions.

Protect from Water

Do not expose the product directly to water, as this can cause electrical shorts, fire or other damage.

Protect from High Temperatures

Exposure to direct sunlight for an extended period of time can produce very high temperatures inside your vehicle. Give the interior a chance to cool down before starting playback.

Do not mount radio within close proximity of engine compartment.

Use the Proper Power Supply

This product is designed to operate with a 12 volt DC negative ground battery system.

Protect the Disc Mechanism

Avoid inserting any foreign objects into the disc slot. Misuse may cause malfunction or permanent damage due to the precise mechanism of this unit.

CAUTION:

THIS MOBILE CD PLAYER IS A CLASS I LASER PRODUCT. THIS UNIT USES A VISIBLE/ INVISIBLE LASER BEAM WHICH COULD CAUSE HAZARDOUS RADIATION IF EXPOSED DIRECTLY. BE SURE TO OPERATE THE MOBILE CD PLAYER AS INSTRUCTED.

USE OF CONTROLS OR ADJUSTMENTS OR PERFORMANCE OR PROCEDURES OTHER THAN THOSE SPECIFIED HEREIN MAY RESULT IN HAZARDOUS RADIATION EXPOSURE.

DO NOT OPEN COVERS AND DO NOT REPAIR BY YOURSELF. PLEASE REFER SERVICING TO A QUALIFIED TECHNICIAN.

WARNING:

- TO REDUCE THE RISK OF FIRE OR ELECTRIC SHOCK, DO NOT EXPOSE THIS EQUIPMENT DIRECTLY TO WATER.
- TO REDUCE THE RISK OF FIRE OR ELECTRIC SHOCK AND INTERFERENCE, USE ONLY THE RECOMMENDED ACCESSORIES.
- THIS DEVICE IS INTENDED FOR CONTINUOUS OPERATION.

DISC NOTES

Compatible Disc Types

Table 1: General Disc Information

Disc Type	Logo	Diameter/ Playable Sides	Playback Time
Audio CD		12 cm single side	74 minutes

NOTE: CD-R and CD-RW discs will not play unless the recording session is closed and the CD is finalized.

Disc Maintenance

- A dirty or defective disc may cause sound dropouts while playing. Before playing, wipe the disc using a clean cloth, working from the center hole towards the outside edge. Never use benzene, thinners, cleaning fluids, anti-static liquids or any other solvent.

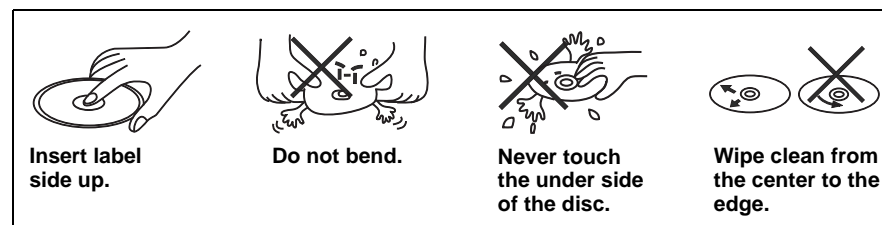

- Be sure to use only round CDs for this unit and do not use any special shape CDs. Use of special shape CDs may cause the unit to malfunction.
- Do not stick paper or tape on the disc. Do not use CDs with labels or stickers attached or that have sticky residue from removed stickers.
- Do not expose discs to direct sunlight or heat sources such as hot air-ducts, or leave them in a vehicle parked in direct sunlight where there can be a considerable rise in temperature inside the vehicle.

NOTE: A disc may become scratched (although not enough to make it unusable) depending on how you handle it and other conditions in the usage environment. These scratches are not an indication of a problem with the player.

INSTALLATION

Before You Begin

1. **Disconnect Battery**
Before you begin, always disconnect the battery negative terminal.
2. **Remove Transport Screws**

Important Notes

- Before final installation, test the wiring connections to make sure the unit is connected properly and the system works.
- Use only the parts included with the unit to ensure proper installation. The use of unauthorized parts can cause malfunctions.
- Consult with your nearest dealer if installation requires the drilling of holes or other modifications to your vehicle.
- Install the unit where it does not interfere with driving and cannot injure passengers if there is a sudden or emergency stop.
- If the installation angle exceeds 30° from horizontal, the unit might not give optimum performance.
- This unit is **not waterproof** and is intended for interior mounting applications only. Exterior mounting of the unit requires use of an ASA approved marine housing.
- Avoid installing the unit where it will be subject to high temperatures from direct sunlight, hot air, or from a heater, or where it would be subject to excessive dust, dirt or vibration.
- Be sure to remove the control panel before installing the unit.

DIN Front/Rear Mount

This unit can be properly installed with either a "Front" (conventional DIN front mount) or "Rear" (DIN rear mount installation, utilizing threaded screw holes at the sides of the unit chassis) mount. For details, refer to installation methods A and B.

DIN Front Mount (Method A)

1. Remove the detachable front panel, if it is attached to the chassis, by pushing the **REL** button.
2. Slide the mounting sleeve off of the chassis if it has not already been removed. If it is locked into position, use the removal keys (supplied) to disengage it. The removal keys are depicted in "Removing the Unit" on page 3.
3. Check the dashboard opening size by sliding the mounting sleeve into it. If the opening is not large enough, carefully cut or file as necessary until the sleeve easily slides into the opening. Do not force the sleeve into the opening or cause it to bend or bow. Check that there will be sufficient space behind the dashboard for the radio chassis.
4. Locate the series of bend tabs along the top, bottom and sides of the mounting sleeve. With the sleeve fully inserted into the dashboard opening, bend as many of the tabs outward as necessary to firmly secure the sleeve to the dashboard.
5. Place the radio in front of the dashboard opening so the wiring can be brought through the mounting sleeve.

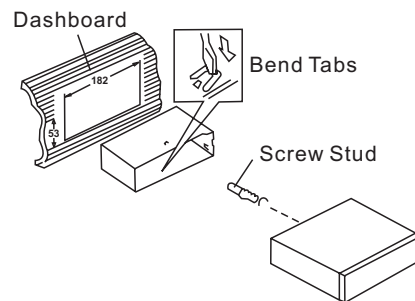

6. Follow the wiring diagram carefully and make certain all connections are secure and insulated with crimp connectors or electrical tape to ensure proper operation.
7. After completing the wiring connections, attach the front panel and turn the unit on to confirm operation (vehicle ignition switch must be on). If the unit does not operate, recheck all wiring until the problem is corrected. Once proper operation is achieved, turn the ignition switch off and proceed with final mounting of the chassis.
8. Carefully slide the radio into the mounting sleeve making sure it is right-side-up until it is fully seated and the spring clips lock it into place.
9. Attach one end of the perforated support strap (supplied) to the screw stud on the rear of the chassis using the hex nut and spring washer provided. Fasten the other end of the perforated strap to a secure part of the dashboard either above or below the radio using the screw and plain washer provided. Bend the strap, as necessary, to position it. **CAUTION:** The rear of the radio must be supported with the strap to prevent damage to the dashboard from the weight of the radio or improper operation due to vibration.
10. Re-attach the front panel to the chassis and test radio operation by referring to the operating instructions for the unit.

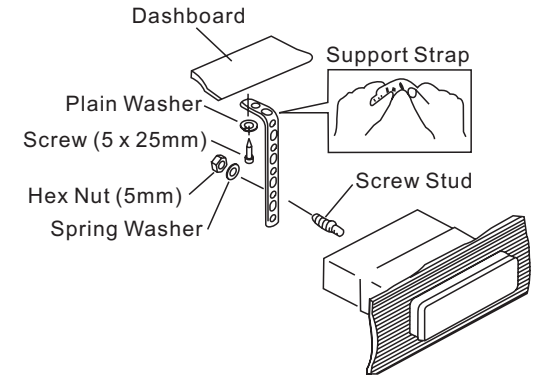

Removing the Unit

To remove the radio after installation:

1. Insert fingers into the groove in the front of frame and pull out to remove the frame. (When re-attaching the frame, point the side with a groove downwards and re-attach.)
2. Insert the removal keys straight back until they click, and then pull the radio out. If removal keys are inserted at an angle, they will not lock properly to release the unit.

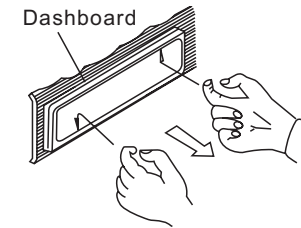

Trim Plate Installation

Push the trim plate against the chassis until it is fitted. **You must do this before you install the control panel, otherwise it can't be attached.**

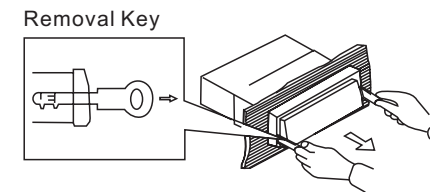

DIN Rear Mount (Method B)

This unit has threaded holes in the chassis side panels which may be used with the original factory mounting brackets of some vehicles to mount the radio to the dashboard. Please consult with your local mobile stereo shop for assistance on this type of installation.

1. Remove the existing factory radio from the dashboard or center console mounting. Save all hardware and brackets as they will be used to mount the new radio.
2. Carefully unsnap the plastic trim ring from the front of the new radio chassis. Remove and discard the trim ring.
3. Remove the factory mounting brackets and hardware from the existing radio and attach them to the new radio. Select a position where the screw holes of the bracket and the screw holes of the main unit are aligned (are fitted). Tighten the screws at 2 places on each side. Do not exceed M5 x 9 MM maximum screw size. Longer screws may damage components inside the chassis.
4. Wire the new radio to the vehicle as outlined in the Universal Installation instructions.
5. Mount the new radio assembly to the dashboard or center console using the reverse procedure of step 1.

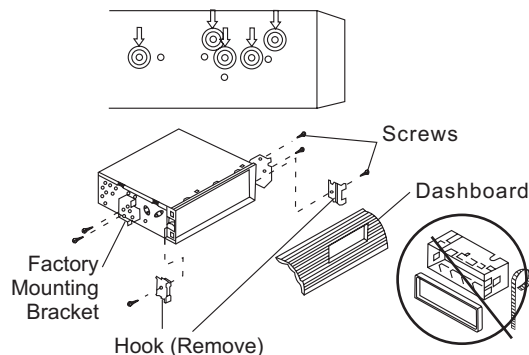

- The DCP can easily be damaged if dropped or subjected to a strong shock. When the release button is pressed and the DCP is unlocked, the vehicle's vibrations may cause it to fall. To prevent damage to the DCP, always store it in a protective case after detaching it.
- The rear connector that connects the main unit and the DCP is an extremely important part. Be careful not to damage it by pressing on it with fingernails, pens, screwdrivers, etc.
- If the DCP is dirty, remove debris with a soft, dry cloth only. You can use a cotton swab soaked in isopropyl alcohol to clean the socket on the back of the DCP.

NOTE: The mounting box, outer trim ring, and half-sleeve are not used for method B installation.

Reconnect Battery

When wiring is complete, reconnect the battery negative terminal.

Detachable Control Panel (DCP)

Removing the Detachable Control Panel (DCP)

1. Turn the power off.
2. Press the **REL** button.
3. Remove the DCP.



Attaching the DCP

1. Attach the panel at the right side first, with point B on the main unit touching point A on the DCP (as shown in the diagram).
2. Press the left side of the DCP onto the main unit until a "click" is heard.

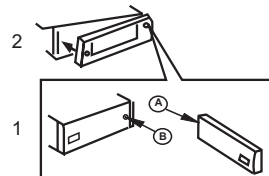

CAUTION:

- DO NOT insert the DCP from the left side. Doing so may damage it.

WIRING

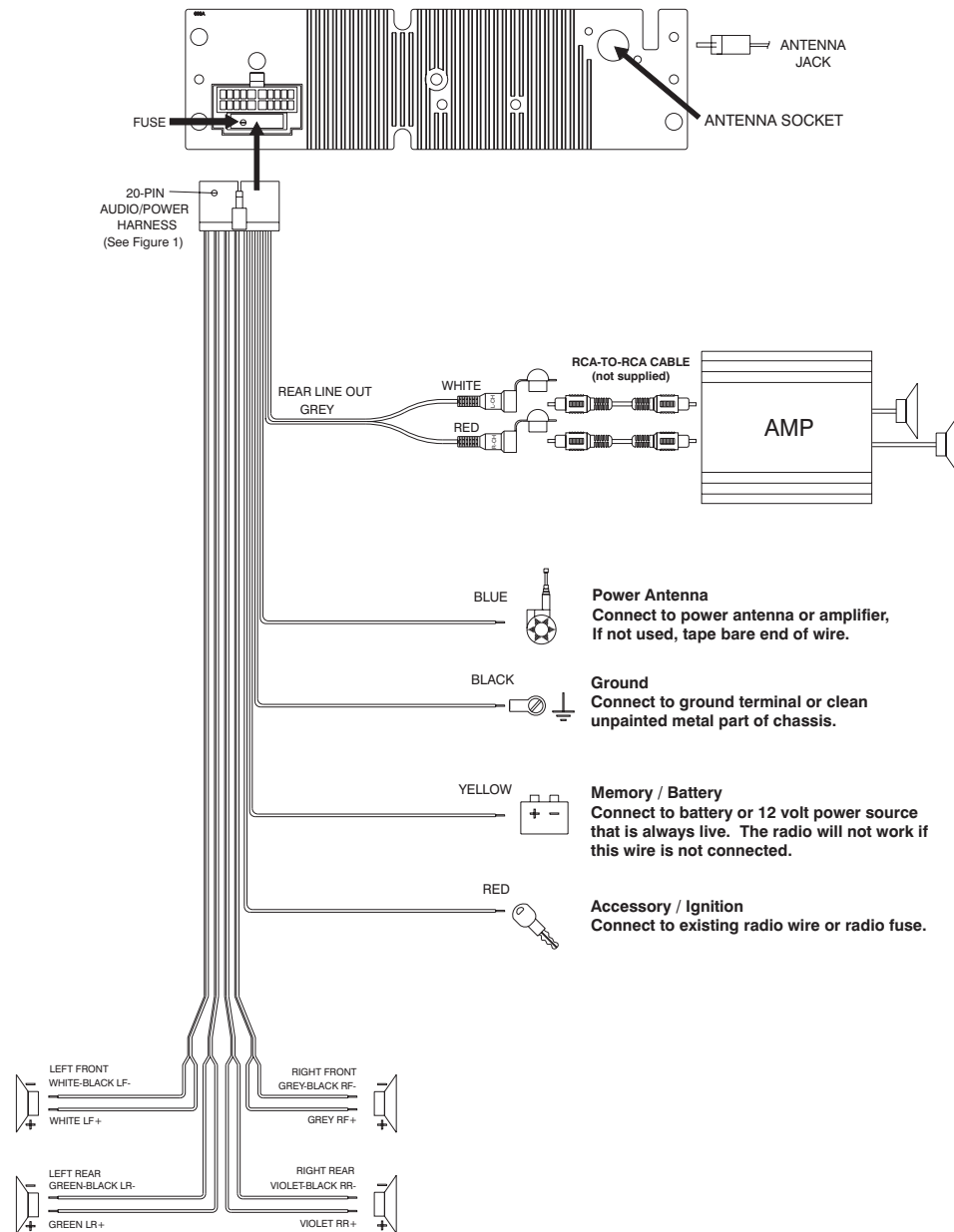
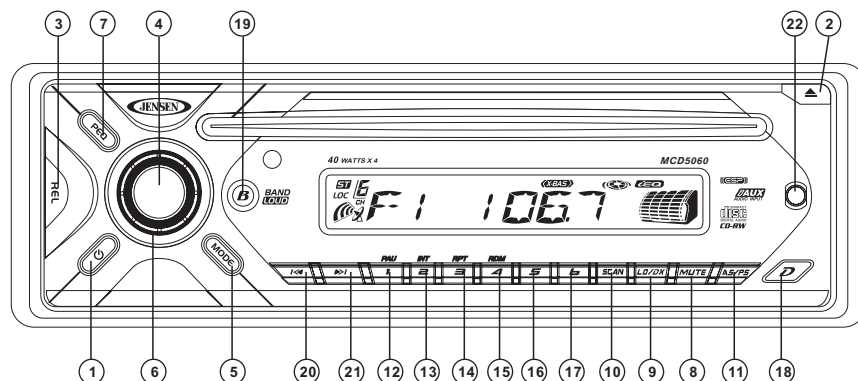

Figure 1: 20 PIN HARNESS PIN CHART

PIN	WIRE COLOR	FUNCTION / LABEL
1	GREY / BLACK	RIGHT FRONT SPEAKER (-)
2	GREY	RIGHT FRONT SPEAKER (+)
3	VIOLET	RIGHT REAR SPEAKER (+)
4	VIOLET/BLACK	RIGHT REAR SPEAKER (-)
5	EMPTY	N/A
6	GREEN	LEFT REAR SPEAKER (+)
7	GREEN / BLACK	LEFT REAR SPEAKER (-)
8	RED	IGNITION (ACC)
9	BLACK	REAR PRE-AMPLIFIER LINE OUT COMMON
10	RED	RIGHT REAR PRE-AMPLIFIER LINE OUT
11	WHITE	LEFT FRONT SPEAKER (+)
12	WHITE / BLACK	LEFT FRONT SPEAKER (-)
13	EMPTY	N/A
14	BLUE	POWER ANTENNA
15	YELLOW	BATTERY (+)
16	BLACK	CHASSIS GROUND
17	EMPTY	N/A
18	EMPTY	N/A
19	EMPTY	N/A
20	WHITE	LEFT REAR PRE-AMPLIFIER LINE OUT

BASIC OPERATION



Control Panel Release (REL)

Press the **REL** button (3) to release the control panel.

Power On/Off (⏻)

Press the ⏻ button (1) to turn the unit ON or OFF.

Volume Control

To increase the volume, rotate the volume control knob (6) clockwise.

To decrease the volume, rotate the volume control knob counter clockwise.

When the volume is adjusted, the volume level is shown on the display panel as a number ranging from 00 (lowest) to 100 (highest).

Mute

Press the **MUTE** button (8) on the control panel to mute the audio output. "Mute" will appear on the display. Press **MUTE** again to restore the audio output to the previous level.

Mode

Press the **MODE** button (5) on the control panel to select a different mode of operation, as indicated on the display panel. Available modes include Radio, CD, and AUX In (optional Auxiliary Input).

Auxiliary Input

1. Connect the external signal to the "Aux In" jack (22) located on the front of the control panel.
2. Press the **MODE** button to select Aux In mode.
3. Press **MODE** again to cancel Aux In mode and return to previous mode.

Display (D)

Press the **D** button (18) on the control panel to view the clock. The LCD will display the clock for 5 seconds, then return to the previous display mode.

Clock Adjustment

With the clock displayed, press the **D** button (18) until the LCD flashes. Press the up >>| (21) button to adjust the hours or the down |<< button (20) to adjust the minutes.

Reset

After releasing the control panel, use a pencil or any non-metallic object to *press and hold* the **RESET** button for five seconds to reset the main unit. The unit will return to the factory default settings. The reset button should be activated for the following reasons:

- initial installation of the unit when all wiring is completed
- function buttons do not operate
- error symbol on the display

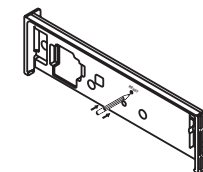

NOTE: If after pressing the **RESET** button the unit still does not function normally, use a cotton swab soaked in isopropyl alcohol to clean the socket on the back of the control panel.

Audio Menu

Press the volume control button (4) on the control panel to access the Audio Menu. You can navigate through the Audio Menu items by pressing the volume control button repeatedly. Once the desired menu item appears on the display, adjust that option by turning the volume control knob within 5 seconds. The unit will automatically exit the Audio Menu after five seconds of inactivity. The following menu items can be adjusted.

Volume Level

Use the volume control knob to adjust the Volume level from "00" (lowest) to "100" (highest).

Bass Level

Use the volume control knob to adjust the Bass level range from "-10" to "+10".

Treble Level

Use the volume control knob to adjust the Treble level range from "-10" to "+10".

Balance

Use the volume control knob to adjust the Balance between the left and right speakers from "10L" (full left) to "10R" (full right). "BAL L=R" represents an equal balance between the left and right speakers.

Fader

Use the volume control knob to adjust the Fader between the rear and front speakers from "10R" (full rear) to "10F" (full front). "FAD R=F" represents an equal balance between the rear and front speakers.

TUNER OPERATION

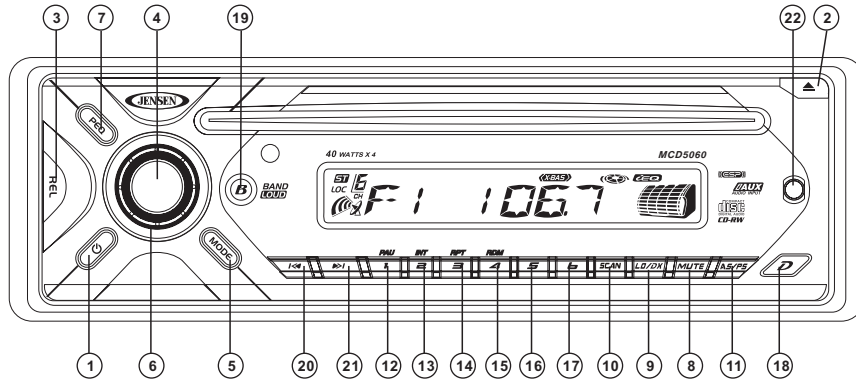

Select a Band

Press the **B** button (19) on the control panel to change between three FM bands and one AM band. Each band stores up to six preset stations.

Tuning

Auto Seek Tuning

Press the up >>| (21) or down |<< button (20) on the control panel for less than three seconds to move to the next station automatically.

Manual Tuning

Press the up >>| (21) or down |<< button (20) for more than three seconds to enter manual tuning mode. Press the up >>| (21) or down |<< button to change the radio frequency number up or down one step. The radio signal strength meter indicates the strength of the current radio station broadcast.

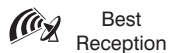

Best
Reception



Worst
Reception

Scan

Press the **SCAN** button (10) to automatically search for stations. Each available station will flash on the display for a few seconds before the next is searched. To select a “flashing” station, press the **SCAN** button again.

Local/Distant (LO/DX)

During radio operation, received signals are usually in stereo mode as indicated by the “ST” icon; however, when the signals are weak or intermittent, you can activate the Local (LOC) mode by pressing the **LO/DX** button (9) (“LOCAL” appears on the display) on the control panel. This mode favors access to local stations whose signals are much stronger; thereby improving radio reception. Press the **LOC** button again to terminate Local receive mode.

Preset Stations

Six numbered preset buttons store and recall stations for each band.

Store a Station

Select a band (if needed), then select a station. Hold a preset button (12-17) for three seconds. The preset number will appear in the display.

Recall a Station

Select a band (if needed). Press a preset button (12-17) to select the corresponding stored station.

Automatically Store / Preset Scan (AS/PS)

Automatically Store

Select a band (if needed). Press **AS/PS** (11) on the control panel for more than three seconds to automatically select six strong stations and store them in the current band. The new stations replace any stations already stored in that band.

Preset Scan

Select a band (if needed). Press **AS/PS** (11) to scan stations stored in the current band. The unit will pause for ten seconds at each preset station. Press **AS/PS** again to stop scanning when the desired station is reached.

Loudness Control (B)

Press the **B** button (19) on the control panel to turn the “Loudness” function on/off. When Loudness is activated, the display will show “X-Bas” for a few seconds.

Preset Equalizer (PEQ)

Press the **PEQ** button (7) to select from the following preset equalizer functions: FLAT > CLASSIC > POP M > ROCK > DSP OFF. When “DSP OFF” is selected, the EQ function is controlled by the Bass/Treble settings.

Stereo

The unit will automatically pick up an FM stereo signal, when available. When in stereo mode, the “ST” icon appears in the display. When no stereo signal is available, the unit will automatically revert to mono operation, and no icon will be displayed.

CD OPERATION

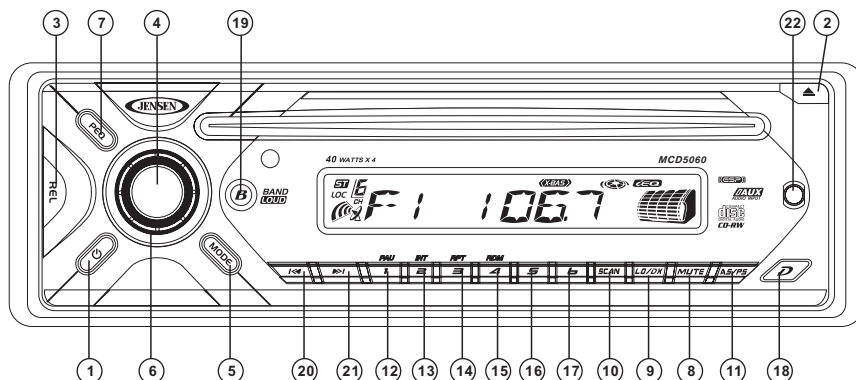

Insert and Eject Disc

Insert a disc, label-side up, with the unit turned on. "S-CDP" will display on the LCD for about 2 seconds and the unit will play the first track on the disc. Press the eject button (2) to stop disc play and eject the disc. The unit does not have to be turned on to eject the disc.

Controlling Disc Playback

Track Select

Press the up >>| (21) or down |<< button (20) on the control panel for less than one second to advance to the next track on the CD. The selected track number will appear on the display. *Press and hold* the up >>| (21) or down |<< button (20) for >1 second to fast forward or fast reverse through the disc. CD play starts when the button is released.

Play/Pause Disc Playback (1/PAU)

Press the 1/PAU button (12) to suspend disc play. Press the 1/PAU button again to resume disc Play.

Intro Scan (2/INT)

Press the 2/INT button (13) on the control panel to play the first 10 seconds of each track sequentially. Press 2/INT again to stop Intro Scan and resume normal play at the current track.

Repeat Play (3/RPT)

Press the 3/RPT button (14) during disc play to repeat play the current track. Press 3/RPT again to stop repeat play

Random Play (4/RDM)

Press the 4/RDM button (15) on the control panel during disc play to play all tracks on a CD in random, shuffled order. Press 4/RDM again to stop random play.

SPECIFICATIONS

CD

Signal to Noise Ratio	≥ 70dB
Sampling Frequency	44.1KHz
Quantization Bits	1 bit
Frequency	5-20,000Hz
Channels	2 Channel (Stereo)

FM Radio

Frequency Range	87.5-107.9MHz
Intermediate Frequency	10.7MHz
Usable Sensitivity	≥ 15dB at S/N 30dB
Stereo Separation	25dB at 1KHz
S/N Ratio	50dB

AM/MW

Frequency Range	530-1710KHz
Intermediate Frequency	450KHz
Usable Sensitivity	≥ 45dB
S/N Ratio	40dB

General

Operating Voltage	DC 11 -14.4
Grounding System	Negative Ground
Speaker Impedance	4 ohms
Power Output	40W x 4

TROUBLESHOOTING

Symptom	Cause	Solution
No power	The vehicle's ignition is not on	If the power supply is properly connected to the vehicle accessory terminal, switch the ignition key to "ACC".
	The fuse is blown	Replace the fuse.
Disc cannot be loaded or ejected	Presence of CD disc inside the player	Remove the disc in the player and insert the new one.
	Inserting the disc in reverse direction	Insert the compact disc with the label facing upward.
	Compact disc is extremely dirty or disc is defective	Clean the disc or try to play a new one.
	Temperature inside the vehicle is too high	Wait until the ambient temperature returns to normal.
No sound	Condensation	Leave the player off for an hour or so, then try again.
	Volume is too low	Adjust volume to audible level.
The operation keys do not work	Wiring is not properly connected.	Check wiring connections.
	Control panel not properly installed	Reinstall control panel.
Sound skips	The built-in microcomputer is not operating properly due to noise	Press the RESET button.
	The installation angle is more than 30 degrees.	Adjust the installation angle to less than 30 degrees.
Cannot tune to radio station, auto-seek does not work	The disc is dirty or defective.	Clean the disc and try to play again or use new disc.
	The antenna cable is not connected.	Insert the antenna cable firmly.
ERROR 1	The signals are too weak.	Select a station manually.
	Mechanism Error	Press the eject button to correct the problem. If the error code does not disappear, consult your nearest service dealer.
ERROR 2	Servo Error	Press the eject button to correct the problem. If the error code does not disappear, consult your nearest service dealer.



ASA Electronics Corporation

www.asaelectronics.com

© 2006 ASA Electronics Corporation

v.071806