





### Accessoires entre la caméra et le support

Spécifications	Qté	Spécifications	Qté
 Vis inox hexagonale M4 X 6L	6	 Rondelle 37.5 X 5 X 0.5mm PP	2
 Rondelle plate inox 4,5 X 9,5 X 1mm	6		
 Vis taraudeuse inox P/H avec rondelle 5 X 16mm	4		
 Clé Allen	1		

### Installation

#### Vis à utiliser

Vis inox hexagonales M4 X 6L  
Rondelles plates 4,5x9,5x1mm  
Clé Allen inox

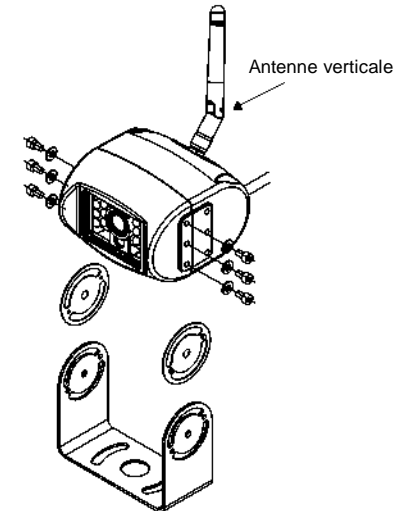

### Dimensions du trou de montage du support

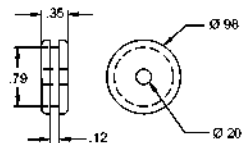

Unité : Pouces

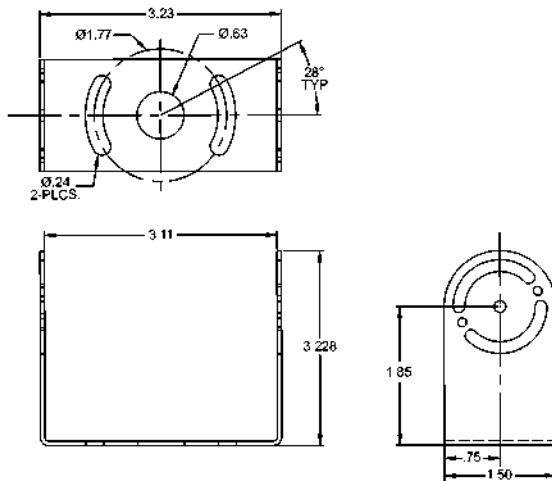

### Dimensions recommandées du trou de l'œillet

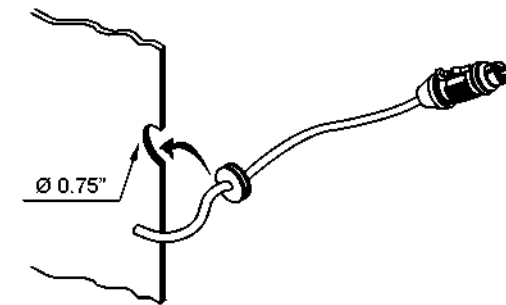

Unité : Pouces